

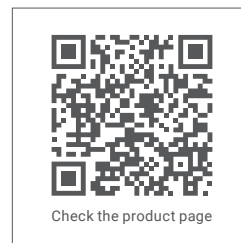

**hush.**  
*acoustics*

Install Guide  
**Galaxy**



*Quiet by design*

1. Locate 3 of the diamond-shaped cloud sections, place them with the open side down on a flat surface as shown below.

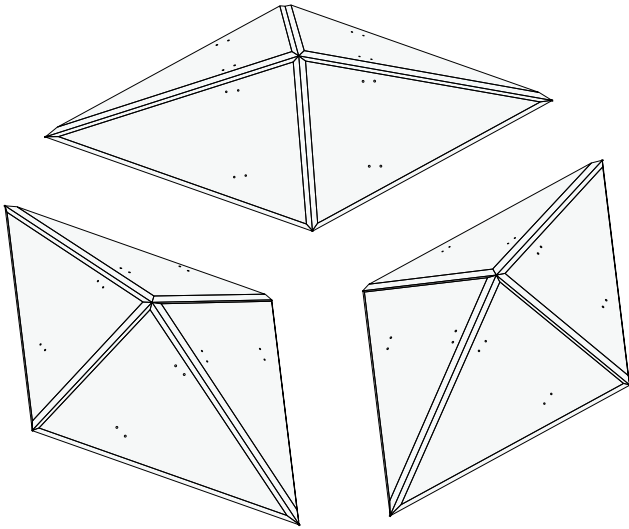

2. Bring the 3 diamond-shaped sections together as shown below, ensuring that they meet in the center.

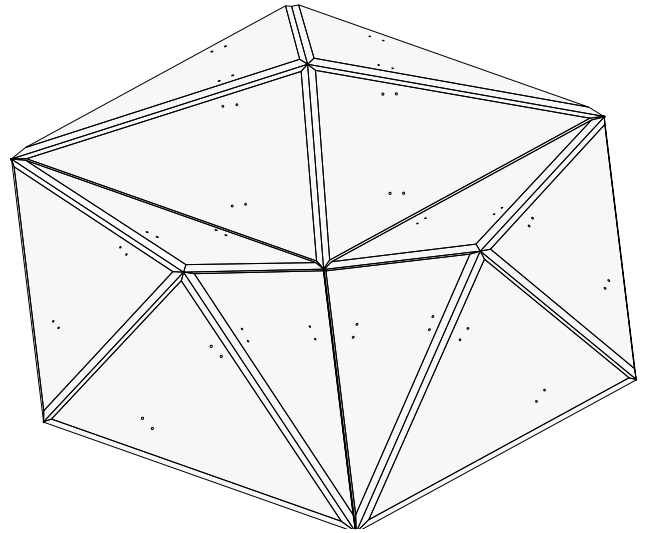

3. Now, apply a small bead of construction adhesive between the pre-marked screw holes on one of the diamond-shaped sections.

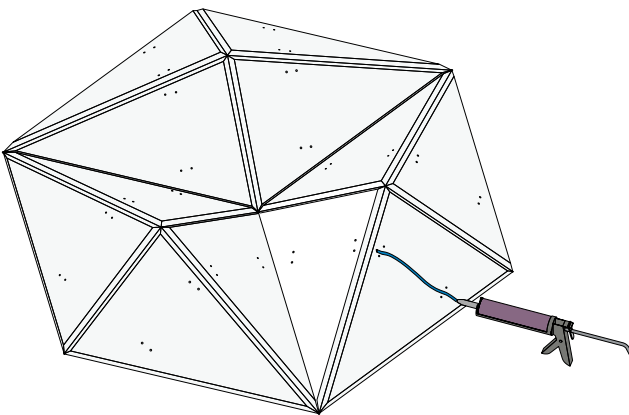

4. Repeat this process to the sections as shown below.

*(Please note; this process needs to be completed as quickly as possible to prevent the glue from beginning to dry.)*

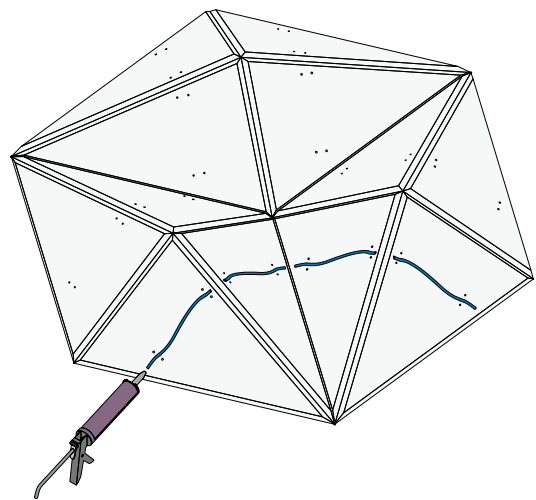

5. Now place the metal bracket over the glue-beads, aligning the holes in the bracket with the pre-marked holes on the cloud sections.

*(Please note; this process needs to be completed as quickly as possible to prevent the glue from beginning to dry.)*

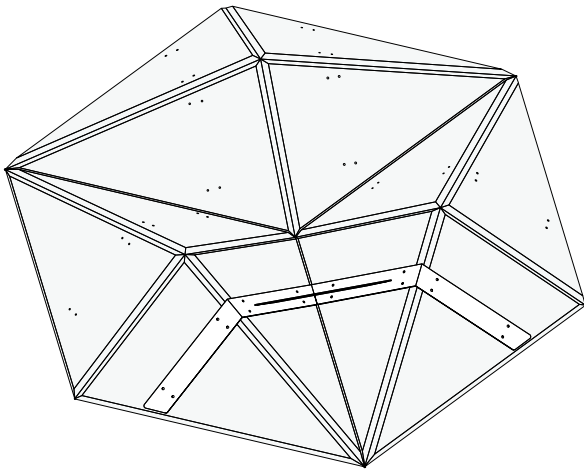

6. Using the screws provided, fasten the metal bracket to the cloud sections. Take care to ensure that the screws are not overtightened.

*(We recommend using a hand screwdriver)*

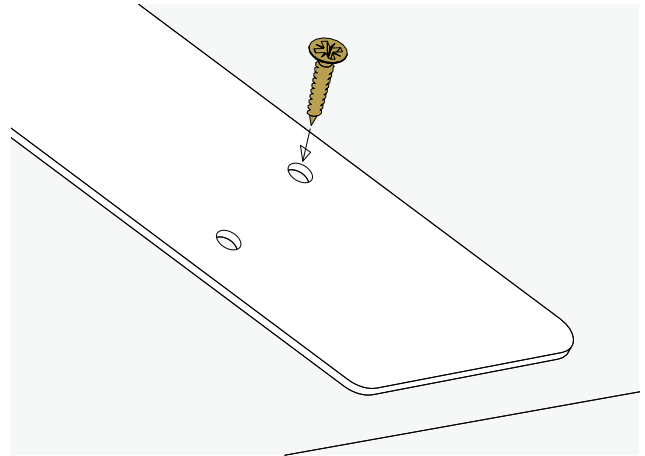

7. Repeat steps 3-6 for the other two brackets, your finished cloud will be as shown below.

*(Please allow the construction adhesive to dry before suspending the cloud. (Refer to instructions on the glue for drying time)*

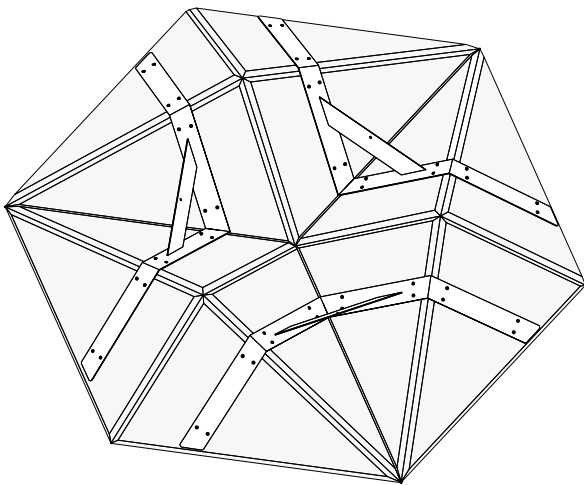

8. After the adhesive has dried, attach a clevis-hook to each of 3 the metal brackets. You are now ready to mount the suspension hardware to the ceiling. Please refer to the Ceiling Hardware Install Guide document.

